



DPD80 Visible Datasheet

Resolved Instruments Inc.
www.resolvedinstruments.com
info@resolvedinstruments.com

General Description

The DPD80 is a low noise digital photodetector that measures the intensity of incident light at a sample rate of 80 MS/s. The data can be streamed directly to your computer through a USB 3.1 cable, which is also used to power the device. Our included software is freely downloadable from our website, <http://www.resolvedinstruments.com>, and allows you to acquire real-time data in either the time or frequency domain, eliminating the need for separate photodetectors, amplifiers, analog to digital converters, oscilloscopes, and spectrum analyzers in your experimental setup. In addition to our user interface you may automate data-taking with our Python and MATLAB libraries.

The DPD80 has a built-in antialiasing filter that can be switched on and off. When the filter is on the noise floor is reduced and frequencies above 40 MHz will be suppressed. When the filter is turned off, it allows the user to view signals above 40 MHz that are mapped from higher Nyquist zones to the first.

Another feature of the DPD80 is its two gain settings. The high gain mode minimizes noise while the low gain mode increases the dynamic range. These two gain modes differ by a factor of 4.

The connections on the DPD80 are summarized in the following table:

Connector	Description
USB 3.1 Type-C	Used to power the device and stream digital data to your host computer. If you are using the analog output and not the digital data the USB cable may be plugged into a USB wall plug to power the device.
Analog Output - SMA	This SMA outputs a voltage between 0V to 3V, linearly corresponding to the intensity of incident on the photodetector. This output allows the DPD80 to function as a drop-in low noise replacement for a typical analog photodetector.
A - MMCX	This is a general purpose 12-bit analog outputs that can generate voltages between 0 V to 3.3 V. The settling time of these outputs is 1 ms.
B - MMCX	This is a general purpose digital output with PWM capability
Trig, Sync - MMCX	These are two digital inputs / outputs that can be used to trigger data-taking of the DPD80 or to synchronize the DPD80 with other instruments.

Absolute Maximum Ratings

Parameter	Rating
Optical input power	5 mW
Voltage trigger input	0 V to +3.3 V
Voltage sync input	0 V to +3.3 V

Specifications

General Specifications

Parameter	Value	Figure
Wavelength sensitivity	500 nm - 950 nm	12
Peak responsivity	0.52 A / W ¹	
Coupling	Free space, free space ball lens or fiber coupled (APC)	
Photodiode active area diameter	0.4 mm	
Ball lens diameter	1.5 mm	
Power source	USB 3.1 Type-C	
Trig, sync logic high	> 2.15 V	
Trig, sync logic low	< 0.82 V	

Digital Data Specifications

Parameter	Value	Figure
Minimum NEP high gain mode	3.0 pW / $\sqrt{\text{Hz}}$	1, 2
Minimum NEP low gain mode	7.5 pW / $\sqrt{\text{Hz}}$	3, 4
Saturation power high gain mode	73 μW	8
Saturation power low gain mode	288 μW	9
Anti-aliasing filter bandwidth	35 MHz	5
Digital bandwidth with aliasing	100 MHz	6
ADC sampling rate	80 MS/s	
ADC vertical resolution	14 bit	
Data output port	USB 3.1 Type-C	

¹ For more information on the photodiode please refer to part number s5973-01 in the hamamatsu datasheet www.hamamatsu.com/resources/pdf/ssd/s5971_etc_kpin1025e.pdf

Analog Output Specifications

Parameter	Value	Figure
Minimum NEP high gain mode	3.0 pW / $\sqrt{\text{Hz}}$	
Minimum NEP low gain mode	7.4 pW / $\sqrt{\text{Hz}}$	
Analog saturation power high gain mode	74 μW	10
Analog saturation power low gain mode	290 μW	11
Analog bandwidth	100 MHz	7
Analog output gain in high gain mode	40.8 kV / W	10
Analog output gain in low gain mode	10.3 kV / W	11
Data output port	SMA	
Analog output impedance	50 Ω	

Typical Performance Characteristics

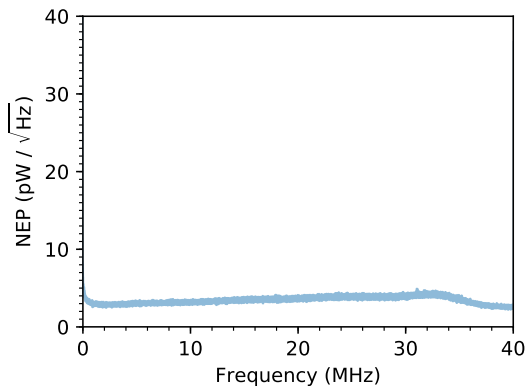

Figure 1: Digital noise floor at 1 kHz BW. High gain mode.

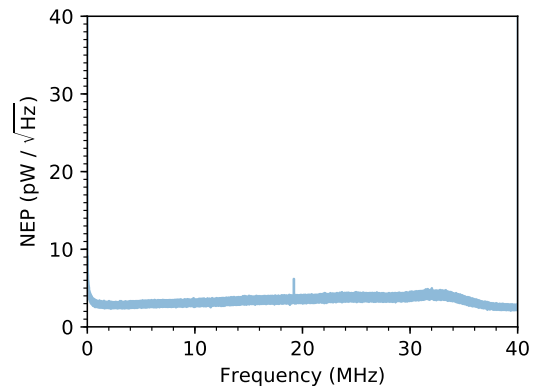

Figure 2: Digital noise floor at 10 Hz BW. High gain mode.

¹ All noise spectrums are single sided.

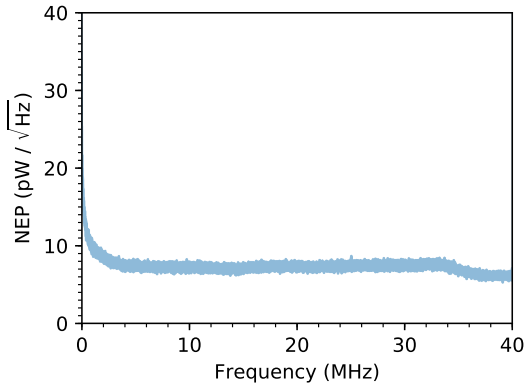

Figure 3: Digital noise floor at 1 kHz BW. Low gain mode.

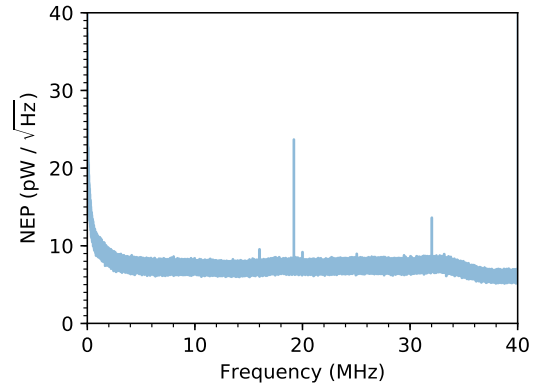

Figure 4: Digital noise floor at 10 Hz BW. Low gain mode.

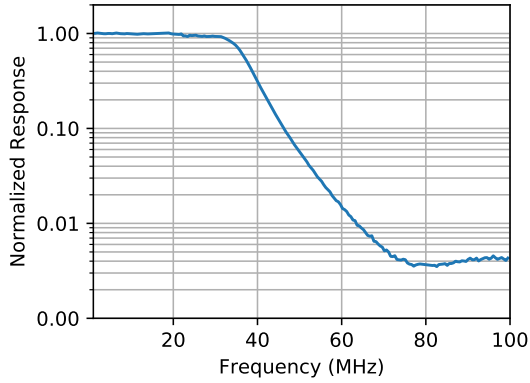

Figure 5: Frequency response of the digital data with anti-aliasing filter on. High gain mode.²

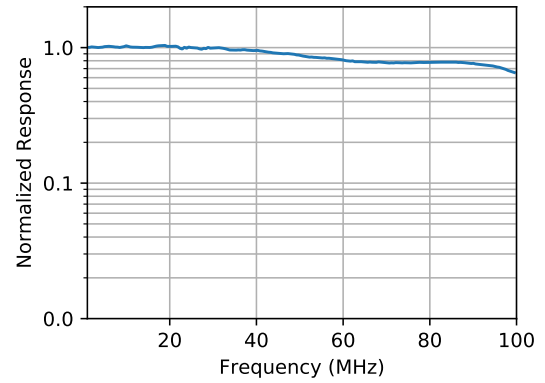

Figure 6: Frequency response of the digital data with anti-aliasing filter turned off. High gain mode.²

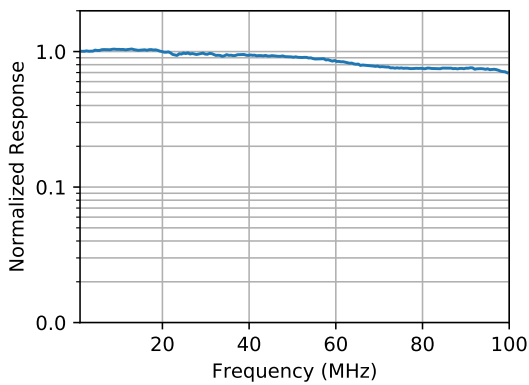

Figure 7: Frequency response of the analog output. High gain mode.

²Frequencies above 40 MHz are aliased.

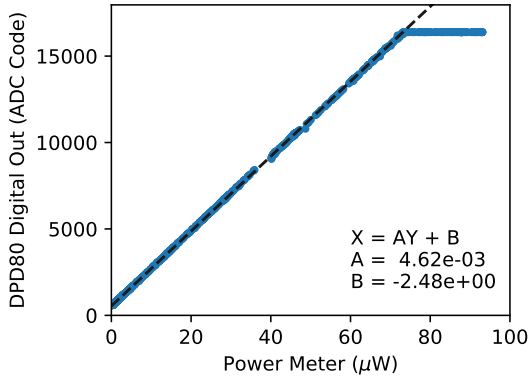

Figure 8: Digital ADC power calibration. High gain mode.

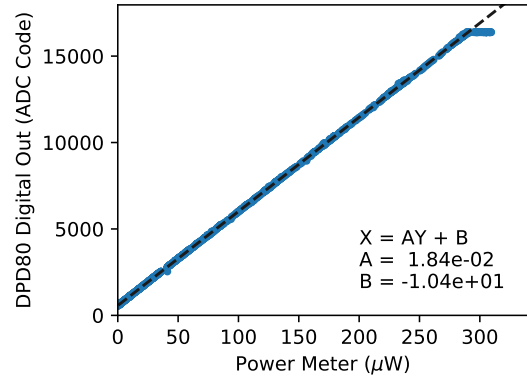

Figure 9: Digital ADC power calibration. Low gain mode.

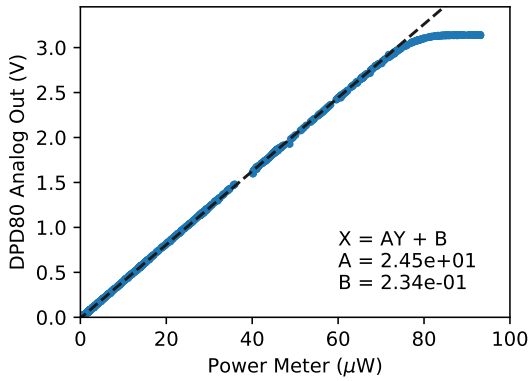

Figure 10: Analog output power calibration. High gain mode.³

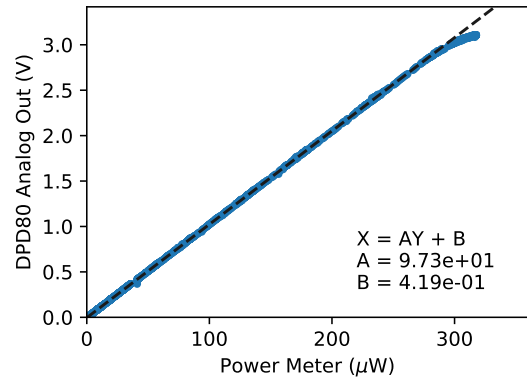

Figure 11: Analog output power calibration. Low gain mode.³

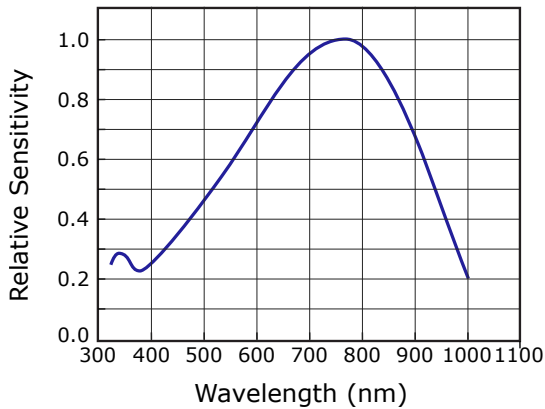
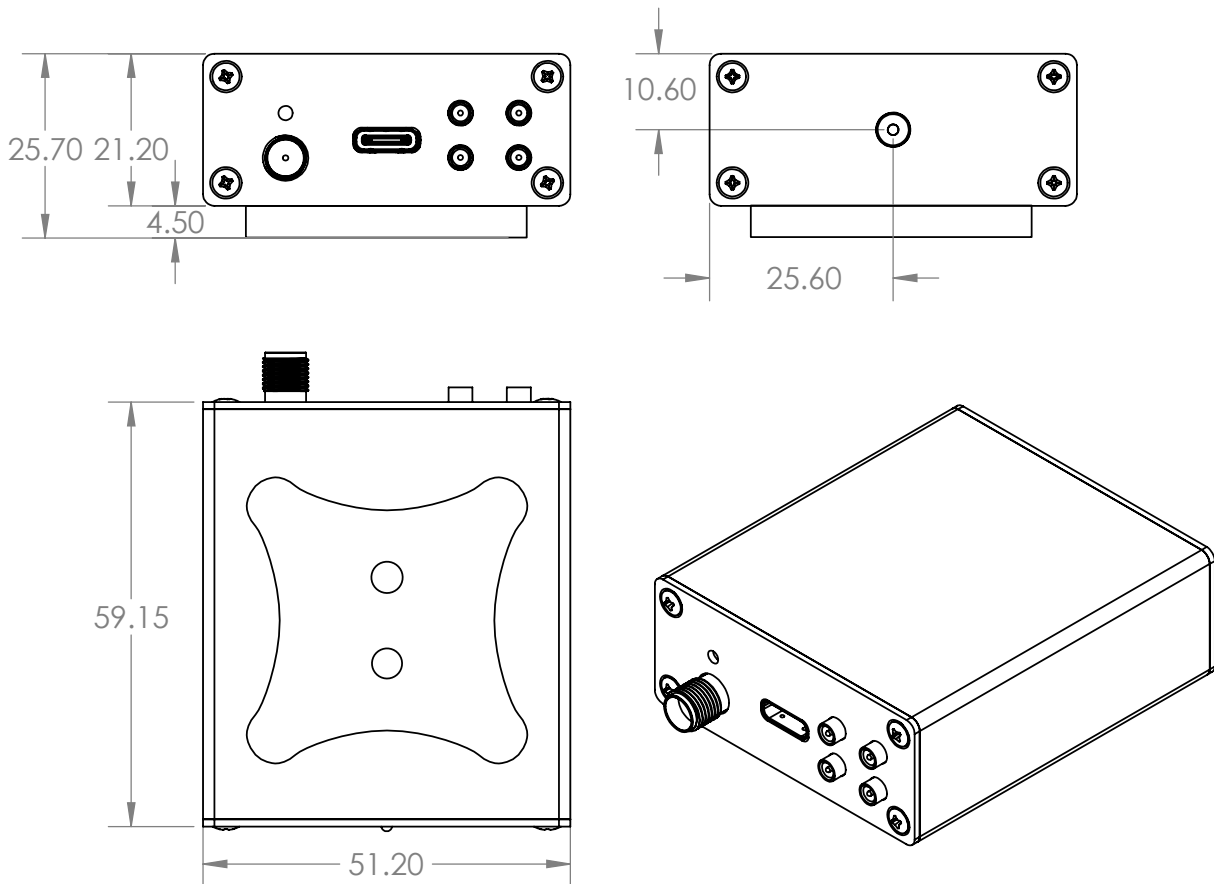

Figure 12: Spectral sensitivity

³ When measuring the analog output voltage with a 50 Ω terminated input, please remember that the voltage measured will be a factor of 2 less than shown in the figure.

Dimensions



All dimensions are in millimeters.